

JANUARY 2024 CATALOGUE



Canopies | Accessories | Roof Racks | Awnings
Rooftop Tents | Cargo Slides | Storage Systems

***Prices are subject to change. E&OE**

Contents

Our factory	1
Shipping & exports	2
Standard canopy features	3
Vehicle models, trim levels & features	4-6
Trim level comparison table	7
Canopy colour options	8-11
Roof racks & roof accessories	12
Aluminium table	13
Telescopic ammo box/wolf pack slides	14
Loadsliders & accessories	15-18
Window options	19
Lighting options	20
Kitchen/storage units, foam inserts	21-22
Vents & insulation	23
Pop up tent & canvas tent	24-25
Awnings	26-27
Commercial range	28
Bed racks	29
Specials & Combo Packages	30-32
How & where to purchase	33

Factory



View outside our factory in Wadeville



Precision laser cutting



Suppliers use Trumf and Amada laser cutting machines



Trumf and Amada CNC bending machines

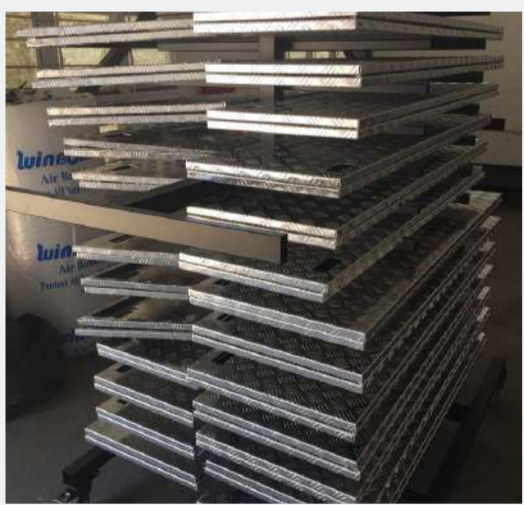

Doors waiting for powder coating

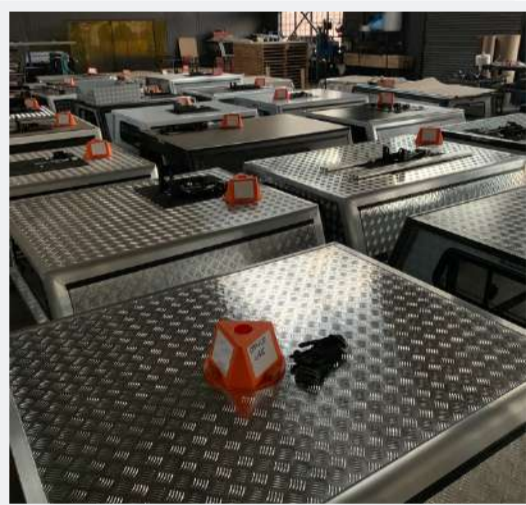

Pre delivery inspection



Parts being powder coated



Digital measuring systems



Water cooled TIG welders allow us to weld at a high current for added strength



An example of a strong and visually pleasing aluminium TIG weld

Shipping & Exports

Canopies are shipped worldwide

- Canopies are bolted to a pallet then crated
- Crated canopies can be stored on their side
- Canopies shipped locally can be strapped to a pallet *on request
- We can arrange shipping using our couriers locally or internationally
- Shipping can also be arranged using our customers/dealers courier locally or internationally
- Small packages are sent locally by courier
- Enclosed crates are available on request
- All canopies and accessories being shipped are tagged with order details and fragile stickers
- Crating allows us to stack three to four canopies high



Standard Features



- ✓ Toughened rear window glass
- ✓ Laser cut aluminium doors
- ✓ Heavy duty locks keyed alike
- ✓ Seamless waterproof door hinges tested to 50000 cycles
- ✓ Rear door grab handle
- ✓ Rear door tapered to match vehicle shape
- ✓ 500 kg rooftop carrying capacity
- ✓ Reinforced aluminium frame 6063 T6 extrusions



NEW internal slotted roof bars and base extrusion

- ✓ Fixed glass front window
- ✓ Pressure equaliser vent
- ✓ All doors double lined with automotive rubber
- ✓ Accessoires can be added easily
- ✓ Smooth corners no visible welds
- ✓ Fitted with heavy duty "no drill" brackets
- ✓ Welded rear door supports
- ✓ Double back door seal

*roof rack & brake light shown is optional

Vehicle Models

We manufacture canopies & accessories for the following vehicle makes and models;



Double Cabs

New 2023 Ranger
Ford Ranger T6/T7/Wildtrak/Raptor 2012 - 2022
Toyota Hilux 2005-present
Toyota Land Cruiser
Mazda BT-50 2008-present
Isuzu KB 2008-present
VW Amarok
Nissan NP300
Nissan Navara D23 and D40
GWM P-Series
Mahindra S10 Karoo
Land Cruiser 79



Super Cabs

New 2023 Ford Ranger
Ford Ranger 2012-present
Mazda BT-50 2012-present
Toyota Hilux 2005-present
Isuzu KB 2013-present



Single Cabs

New 2023 Ford Ranger
Ford Ranger 2012-present
Mazda BT-50 2012-present
Toyota Hilux 2016-present
Land Cruiser 79

Canopy Trim Levels



Entry Level

From R21990 for double cabs
From R23990 for super cabs
From R28990 for single cabs

Uncoated aluminium frame
Uncoated tread pattern panels
Fixed glass windows front & back
Three pop up doors
Pressure vent
Add accessories at any stage

*Powder coat frame for an additional R2000
*Land Cruiser & Mahindra additional R2000



Mid Range

From R25990 for double cabs
From R28990 for super cabs
From R31990 for single cabs

Powder coated aluminium frame;
White/black/charcoal or silver frame
Powder coated aluminium panels;
White/black/charcoal or silver panels
Fixed glass windows front & back
Three pop up doors
Pressure vent
Roof rails
Add accessories at any stage

*Land Cruiser & Mahindra additional R2000



Pro Series

From R28990 for double cabs
From R30990 for super cabs
POA single cabs

All the Mid Range canopy features as well as;
Rear window security barrier
LED brake light
Mounting points for all accessories
Add accessories at any stage

*Land Cruiser & Mahindra additional R2000



Pro Series Ultimate Edition

All the Pro Series canopy features as well as;
Smooth corners on canopy frame
3 x LED interior lights
Heat insulation on the ceiling of the canopy
Add accessories at any stage

*Land Cruiser & Mahindra additional R2000

From R32990 for double cabs
From R34990 for super cabs
POA for single cabs

Canopy Features

Standard features of the GZ Aluminium Canopy:

- 3000kg static load rating officially tested and certified
- Average canopy weight for double cabs +-55kg
- Industry leading 12 year frame warranty & service plan linked to your unique serial number
- Pressure equalizer vent which neutralizes the pressure in the load bin reducing dust intake
- Continuous Centaflex dustproof and waterproof hinges
- Reinforced heavy duty internal slotted roof bars allows you to easy add accessories with no drilling
- Slotted base extrusion which also allows you to easliy add accessories without drilling
- 2 x high quality gas struts per door mounted onto 304 stainless steel brackets for added strength
- Large pressure leaver locks with Neoprene weatherproof & UV resistant seals
- Toughened SABS safety glass front and back, rear window tinted for added security
- Canopy components are easy to repair/replace if damaged
- All of our canopies are easy to fit and remove using basic hand tools
- Add accessories at any stage allowing yopu to build your setup over time or all at once
- Over 30 additional add on accessories that can be fitted without any drilling
- The most feature packed canopy on the market
- Easily add a roof rack or load bars to allowing you to carry cargo/tents/ladders etc
- All products and accessories are tested by ourselves and some select customers. We have one customer in Europe testing our products through over 19 countries & 3 continents with no issues
- We offer advice on canopy options and accessory choices for commercial, leisure and overlanding

Mid Range Canopy Additional Features:

- Frame colour choice black/white/charcoal/silver (colour matching optional)
- Doors & roof colour choice black/white/charcoal/silver
- Roof rails fitted with high tensile M8 bolts, allows you to fit tents, roof rack or load bars

Pro Series Canopy Additional Features:

- LED brake light with wiring harness
- Internal magnetic battery operated switch light
- Rear window security barrier
- Frame colour choice black/white/charcoal/silver (colour matching optional)
- Doors & roof colour choice black/white/charcoal/silver

Ultimate Edition Canopy Additional Features:

- Internal heat insulation fitted to the ceiling of the canopy
- 3 x wired LED lights white & amber
- LED brake light with wiring harness
- Frame colour choice black/white/charcoal/silver (colour matching optional)
- Doors & roof colour choice black/white/charcoal/silver

Canopy Comparison

	Entry Level	Entry Level Plus	Mid Range	Pro Series	Pro Series Ultimate Edition
Aluminium frame	Standard	Standard	Standard	Standard	Standard
Aluminium doors & roof	Standard	Standard	Standard	Standard	Standard
Frame warranty	12 years	12 years	12 years	12 years	12 years
Component warranty	2 years	2 years	2 years	2 years	2 years
Fixed glass windows front & back	Standard	Standard	Standard	Standard	Standard
Rear tinted window	Standard	Standard	Standard	Standard	Standard
Pressure equaliser vent	Standard	Standard	Standard	Standard	Standard
Seamless waterproof hinges	Standard	Standard	Standard	Standard	Standard
Three pop up doors gas assisted*	Standard	Standard	Standard	Standard	Standard
Six heavy duty locks keyed alike	Standard	Standard	Standard	Standard	Standard
Polished mill finish aluminium frame	Standard	N/A	N/A	N/A	N/A
Powder coated frame in your choice of colour	N/A	Standard	Standard	Standard	Standard
Uncoated tread pattern doors & roof	Standard	Standard	N/A	N/A	N/A
Powder coated doors in your choice of colour	N/A	N/A	Standard	Standard	Standard
Choice between smooth or tread doors & roof	Tread only	Tread only	Tread or Smooth	Tread or Smooth	Tread or Smooth
Roof rails (for easy fitment of rooftop accessories)	Optional	Optional	Standard	Standard	Standard
Internal mounting points for accessories	Standard	Standard	Standard	Standard	Standard
LED brake light	Optional	Optional	Optional	Standard	Standard
Smooth corners with no visible welds	Optional	Optional	Standard	Standard	Standard
Internal LED lights	Optional	Optional	Optional	Optional	Standard
Internal heat insulation	Optional	Optional	Optional	Optional	Standard
Ability to add accessories at a later stage	Yes	Yes	Yes	Yes	Yes
Tested & certified static rooftop carrying capacity	3000 kg	3000 kg	3000 kg	3000 kg	3000 kg
Dynamic rooftop carrying capacity (while driving)	500kg	500kg	500kg	500kg	500kg
Easy to fit a roof rack or rooftop tent	Yes	Yes	Yes	Yes	Yes
Rear window security barrier	Optional	Optional	Optional	Standard	Standard

*specifications apply to all double cab, super cab and single cab canopies
 *single cabs have 5 pop up doors where all other canopies have 3 pop up doors

Colour Options

Tread finish panel colour samples



Black tread

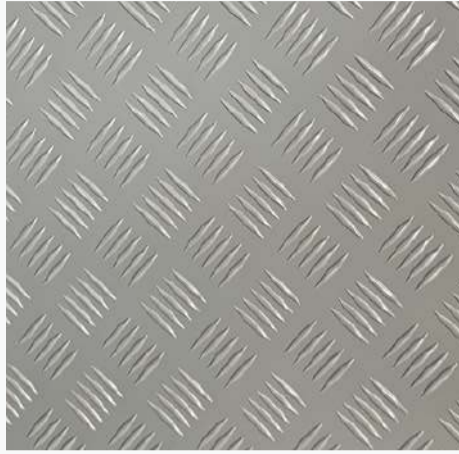

Silver tread

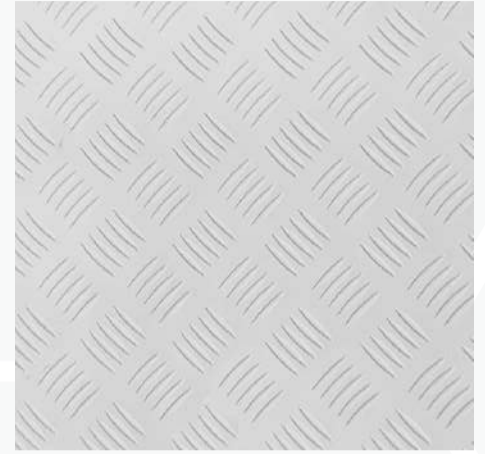

White tread



Charcoal tread



Uncoated mill tread
*Entry & Entry Plus

Smooth finish panel colour samples

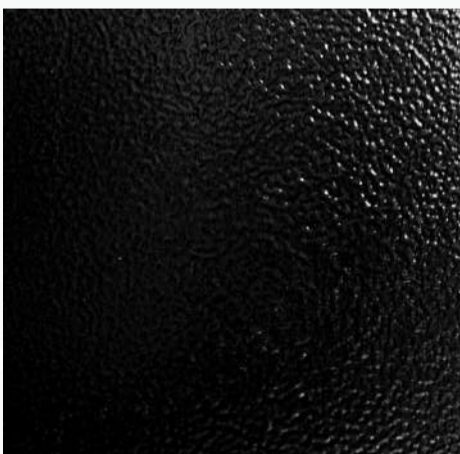

Black smooth

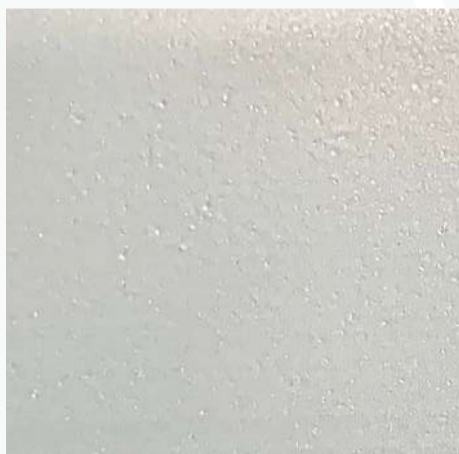

Silver smooth

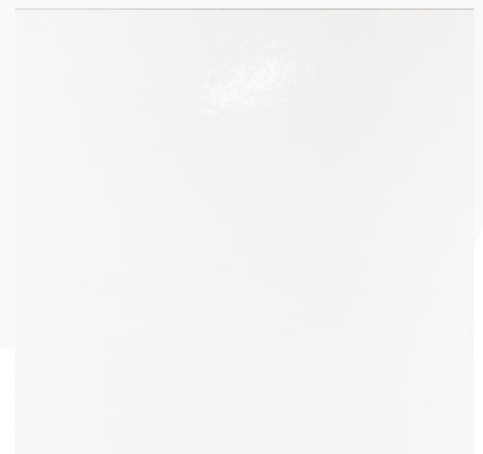

White smooth



Charcoal smooth



Uncoated polished
*Entry Level frame only

Colour Options



Polished uncoated frame
Uncoated tread doors



White frame
Uncoated tread doors



Silver frame
Uncoated tread doors



Charcoal frame
Uncoated tread doors



Black frame
Uncoated tread doors



White frame
Silver tread doors



White frame
White smooth doors



White frame
Black smooth doors



Black frame
Black smooth doors



White frame
Charcoal smooth doors



Black frame
Black smooth doors



Charcoal frame
Charcoal smooth doors

Colour Options



Silver frame
Charcoal smooth doors



White frame
Black tread doors



Charcoal frame
Silver tread doors



Silver frame
Black smooth doors



Silver frame
Silver tread doors



Black frame
Charcoal tread doors



Charcoal frame
Charcoal tread doors



Silver frame
Charcoal tread doors



White frame
Charcoal tread doors



Black frame
Black smooth doors



Black frame
Black smooth doors



Black frame
Black smooth doors

Colour Matching

Colour matching available on all canopy frames

R4600 for double cabs

R5600 for super cabs, Mahindra double cab & Land Cruiser double cab

POA for single cabs

*VIN number required when ordering

*Any trim level can have their frame painted



Roof Racks



Roof tracks - bolted onto the roof of the canopy allowing you to easily add load bars, racks, tents etc.

R1200 for double cabs
R1400 for super cabs
R1800 for single cabs



Roof tracks with two load bars includes 6 x eye hooks

R3200 for double cabs
R3400 for super cabs
R4600 for single cabs*
 *single cab uses three load bars



Slat Rack roof rack - 5 x T-Slot slats with 100mm perimeter frame

R4900 for double cabs
R5900 for super cabs

NEW

Light duty fully adjustable load bars

R1290 for double cabs
R1290 for super cabs
R1990 for single cabs*
 *single cab uses three load bars

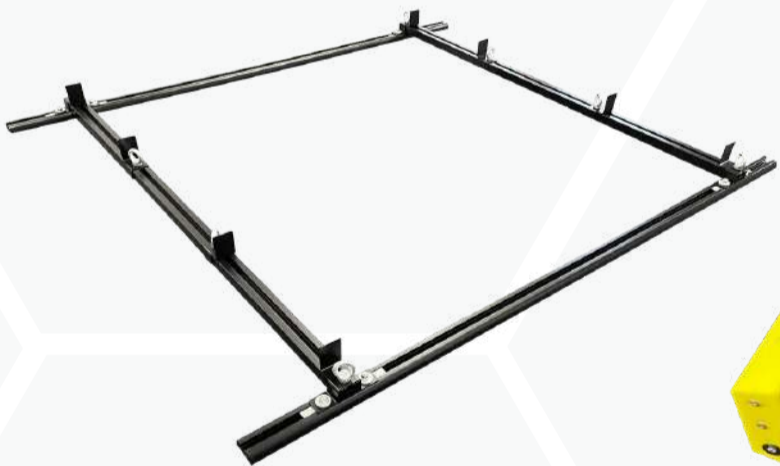

NEW

Speed Rack - Modular Quick & Easy To Use Roof Rack

Quick & easy fitment of rack accessories
 All aluminium construction
 No wind deflector needed
 Strong, lightweight and versatile
 "Quick Fit" T-Bolt Technology
 Includes 6 x eye hooks

R6900 for double cab racks 1515mmx1265mm
R7900 for super cab racks 1723mmx1265mm
R9900 for single cab racks 2139mmx1265mm



Aluminium Table

R3990

***including table slide**

One of the most popular accessories we sell. Perfect for any occasion.

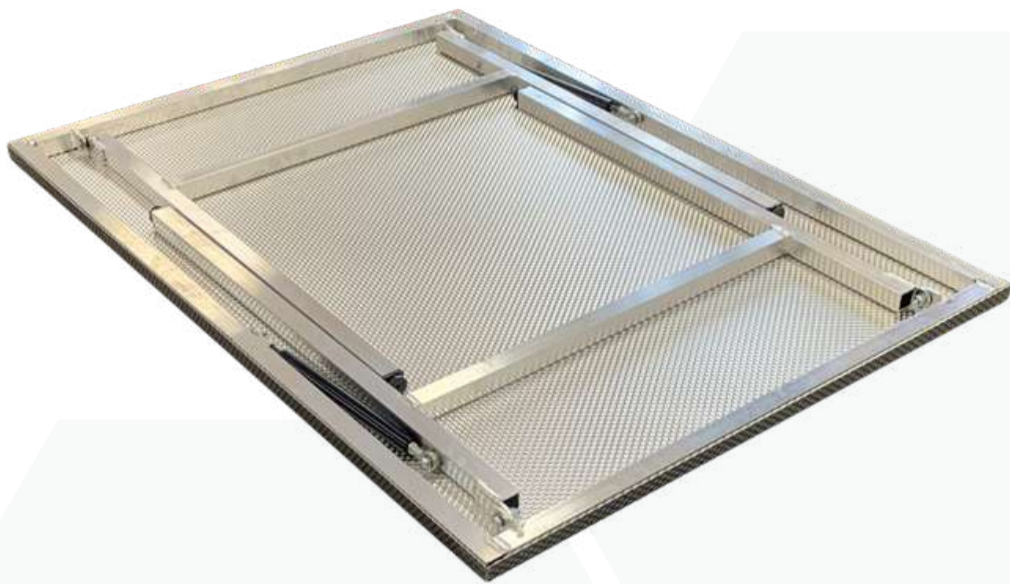

Only 32mm thick and 7kg overall weight
Legs close neatly without any latches or straps

Legs open when table is turned
right side up

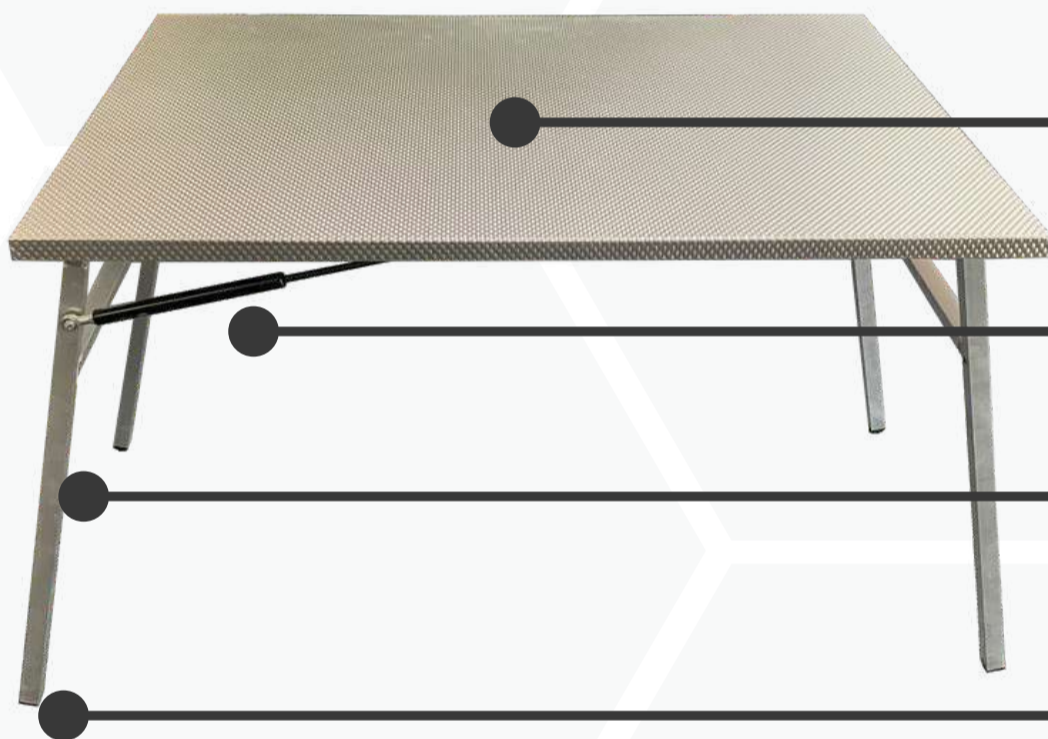

Rigidized aluminium table top

Gas assisted opening legs

Aluminium legs and framework

Height adjustable feet



New table canvas cover with pouches
and storage bag

R2990



Completely out of sight and easy to access

Ammo Box Slides

Telescopic ammo box/crate holder;

R4290 *excludes ammo boxes

- Fits three standard or high top ammo boxes or similar size boxes 505mm wide
- Slides out 1 meter on passenger or drivers side
- Tray and base extrusions made from aluminium
- Angle supports and latches made from 304 stainless steel
- All components powder coated black
- Easy to fit and entire unit is easily removed
- Cut outs for ratchet straps
- Eye hooks supplied if additional straps are required



Typical passenger side setup with slide at full extension



Full setup showing our telescopic ammo box slide, 2 x kitchen units & aluminium table



Rifle Box - attaches to underneath of telescopic ammo box slide
Extra storage & additional security

R2990



Telescopic eye hook angles. Keeps ammo boxes from moving. Quick and easy to strap 3 x boxes

Fixed ammo box/crate holder; **R2900**

- Fits three standard or high top ammo boxes or similar size boxes 505mm wide
- Fixed in place but boxes can slide along the fixed extrusions
- Tray and base extrusions made from aluminium
- Supports and latches made from 304 stainless steel
- All components powder coated black
- Easy to fit and entire unit is easily removed
- 6 x eye hooks included



The Loadslider

From R16990 for double cabs
From R18990 for super cabs



**Unique "drop & turn"
T-Bolt Technology**

Our Loadslider is the ultimate cargo slide for your vehicle
The most advanced cargo slide on the market

Standard Features

- 80% extension at 350kg capacity
- 39 stopping positions
- Easy to install and remove
- Works on uneven surfaces
- Various accessories available
- No more climbing into your vehicle load bin to fetch things
- Only 85mm high when installed
- Build in safety features
- Safe & easy to use
- Ergonomic handle & locking mechanism
- There is no other slide like this on the market
- Components are easy to replace
- All aluminium tray with T-Slot extrusions/tracks
- Accessories can be added
- Perfect for leisure, commercial and overlanding
- 6 x eye hooks with t-bolts included



Low profile design



Maximises storage space



**Easy to fit with multiple
slotted mounting holes**

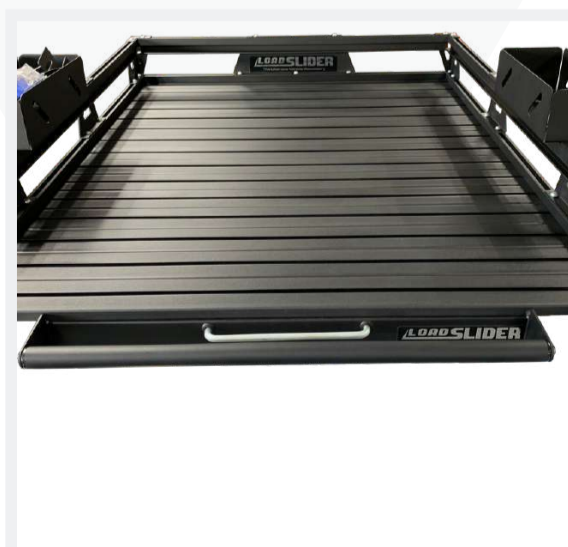

**Ergonomic handle
and locking mechanism**



**Easy access to your entire
load bin**

**Available for most makes of double cabs and super cabs*

Loadslider Accessories



Standard Loadslider
without perimeter rail

From R16990 for double cabs
From R18990 for super cabs



Loadslider with perimeter rail

From R18990 for double cabs
From R20990 for super cabs



Loadslider with perimeter rail & 2 x bin boxes

From R20370 for double cabs
From R22370 for super cabs



Bin boxes easily bolt
anywhere on the Loadslider

R690 each



Perimeter rail only

R2000



Additional eye hooks

R25 each



Stretchy Straps

R250 each



Corner brackets including 2 x eye hooks

R140 each



Divider plate including 2 x eye hooks

R690 each

Loadslider Accessories

NEW PRODUCTS

We have expanded our range of Loadslider Accessories. Listed below are some of the new accessories, with more on the way.



Medium Fridge Slide R3990 incl.vat
Large Fridge Slide R4990 incl.vat

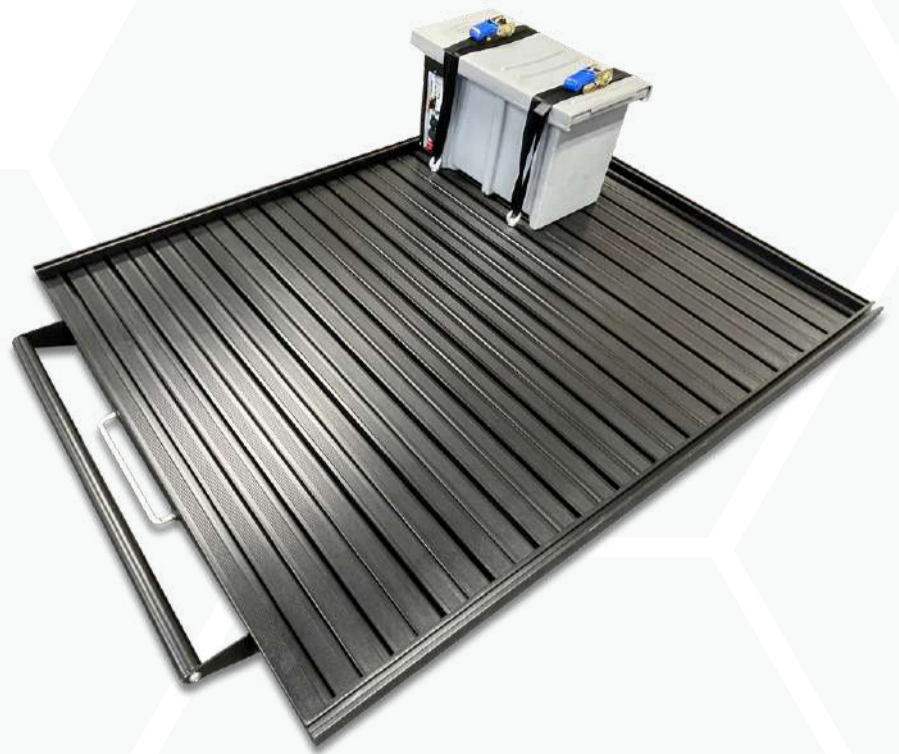

Battery Box Straps R590 incl.vat
Includes 2 x straps & 4 x eye hooks



Heavy duty double corner bracket R190 incl.vat



50 Litre water tank kit R1990 incl.vat
Includes 2 x straps & 4 x eye hooks



Cable protection chain from R1200 incl.vat



Side mounted bin boxes R890 each incl.vat

Loadslider Gallery



Window Options

Various window options available for your canopy

- All glass used is SABS toughened safety glass
- Rear glass windows come standard with a grey tint
- Front glass, front sliding windows & side sliding windows use clear glass
- 4mm thickness used for all glass and windows
- Smash and grab can be fitted by any PG Autoglass Centre



Standard tinted rear glass window



Solid rear door "no window" option
no cost option



Single cab side sliding windows
R2600 per pair



Double cab & super cab side sliding windows
R2600 per pair



Rear window safety mesh
R1490



Front sliding window
R1200

*all canopies come standard with fixed glass front & rear windows

Lighting Options

Internal LED light set consisting of three wired 12 volt white/amber lights
All three lights are joined to a cigarette lighter socket
Vehicle needs to have a dual battery or 12 volt socket prewired to power the lights
Wireless on/off switch remote available
R1990 for a set of 3 lights installed



Left hand side door LED light



Right hand side door LED light



Rear door LED light



White light for maximum visibility



Amber light provides less visibility but doesn't attract insects



LED brake light
Can be fitted to any canopy trim level
Ford approved harness available
Toyota approved Hilux Revo harness available

R660 each
Ranger/Revo wiring harness R890



USB Rechargeable LED Light

Sticks on a magnetic strip that can be positioned anywhere inside the canopy. Provides adequate light without wiring up your vehicle or using a dual battery

White/Amber/Red
R390 each

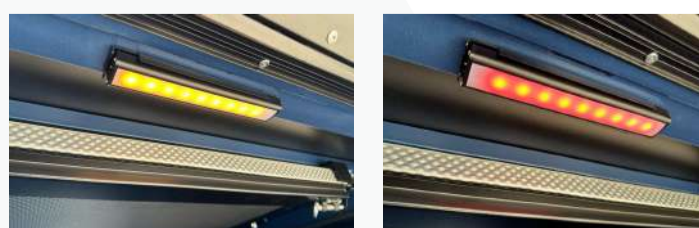

Kitchen Units

We offer a wide range of kitchen/storage units and related accessories

- Kitchen units are made entirely from aluminium
- Easy to fit, each unit bolts in place with 4 x M8 bolts
- Once fitted, these units will not come loose even when travelling on corrugated roads for extended periods
- Each unit is 50% of the length of the side door opening for double cabs and super cabs. For single cabs where double doors are standard, each unit is the width of one side door opening
- All units and accessories can be added to your canopy at a later stage



Powder coated kitchen unit
R1800 each



Powder coated kitchen unit with optional carpeting
R2400 each
***carpeting R600**



Powder coated kitchen unit with optional fixed shelf & full carpeting
R2750 each



Powder coated kitchen unit shelf
***shelf R250** ***shelf carpeting R100**

New drop down aluminium shelf
Includes storage bag
Clips onto base of canopy
R1800 each

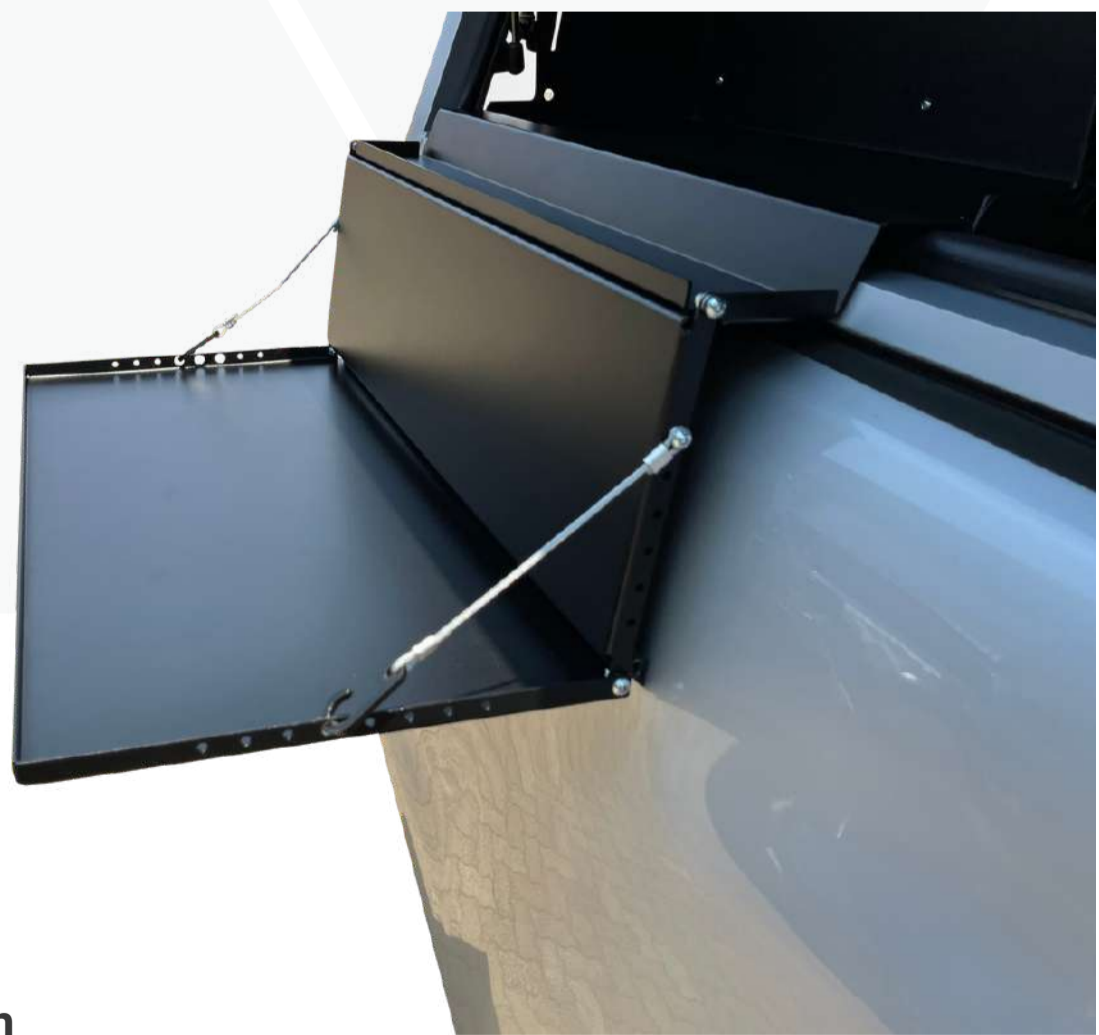

Kitchen units can be fitted in conjunction with other accessories such as our ammo box slides and aluminium table

Kitchen Units

Canvas Cutlery Bag **R2200 each**

- High quality canvas cutlery bags
- Easy to fit and pack into our kitchen units
- Cutlery bag is removable and can be carried to cooking/eating area
- Any cutlery, crockery, cooking utensils and other kitchen related items can be packed
- No restrictions on what items can be packed
- More usable than foam inserts



Foam Inserts **POA**

- We outsource all of our foam insert work to HD Foam Solutions
- Foam inserts are easy to fit and glue into our kitchen units
- All foam inserts are custom made to your requirements
- Items you require need to be supplied to HD Foam Solutions so they can measure everything up and send you different layouts
- Once you decide on a layout the foam inserts will be cut out and sent either to the customer or to us to install into the kitchen unit



Vents & Insulation

All canopies come standard with a front mounted pressure vent
Our pressure vent is suitable for ordinary conditions
Pop up vents are needed for fine or excessively dusty roads
Vents should be used in conjunction with a load bin/tail gate dust seal kit



Plain aluminium pop up vent
R990 each



Powder coated aluminium pop up vent
to match door colour
R1200 each

Tail gate dust seal kits

*not compatible with plastic bin liners



Ford Ranger 2012 - 2022
R1800 each



Toyota Hilux GD6 2016 - present
R1800 each

2023 New Gen Ford Ranger
R2200 each



Heat Insulation

Available for all canopies
Laser cut from heat insulation foam sheets
Reduces internal canopy temperature

R1490 double cab roof insulation
R1690 super cab roof insulation
Single cabs POA

Pop up Tent

from R42900
*excludes fitment



**Optional 270 degree awning*



- Lightweight high quality tent
- Ladder included
- Fits onto 3 x load bars or a roof rack
- Easily sleeps two people
- Various ways to be fitted to canopy
- Strong honeycomb floor & roof
- Heavy duty zips
- 6 x internal storage pockets

Optional Tech Pack includes: **R2000**

- 4 x USB chargers, 1 x USB-C charger
- Internal LED light
- Cigarette socket
- Voltmeter and temperature gauge

[Click here to view all specs & videos on our website](#)



Telescopic ladder included



Carbon fibre panels



Heavy duty handle and locks



Aerodynamic design

Canvas Rooftop Tent

from R15990
*excludes fitment



1.4m Deluxe Canvas Tentco Rooftop Tent Specs

- 1.4m x 2.4m
- 280gms ripstop canvas
- Heat vent
- Four windows with rainfly
- Ladder included
- Mattress included
- Fits onto canopies or bed racks
- Can be fitted in combination with an awning or a shower cube



270 Degree Awning

R14990

*excludes fitment



- All aluminium construction
- High quality reflective ripstop canvas
- Heavy duty awning bag
- Can be used as a free standing awning
- 3 x drop down legs included
- One person setup
- Sets up in seconds
- Minimal wind noise while travelling
- Fully powder coated matt black

Ways to fit our awning;

- Onto a pair of load bars
- On our heavy duty roof rack
- Onto other makes of roof racks
- Onto our pop up rooftop tent



Full 270 degree coverage



Optional side wall kit



Easily stores away in seconds



Can also be fitted to a tent

2,5m Pull Out Awning

R3900

*excludes fitment



- All aluminium construction
- High quality canvas
- Heavy duty awning bag
- Two person setup
- No wind noise while travelling
- Lightweight and easy to fit
- Simple and easy setup

Ways to fit our awning;

- Directly to canopy roof with roof tracks
- Onto a pair of load bars
- On our heavy duty roof rack
- Onto other makes of roof racks
- Onto our pop up rooftop tent



Commercial Range

We offer a wide range of canopies and accessories for commercial use
Our all aluminium canopies are lighter and stronger than fibreglass and steel canopies
Every single cab canopy come standard with five pop up doors for easy access
Various colour options available
Easily add load bars, roof racks, contractors racks and other usefull accessories



Five pop up doors for easy access to load bin



Popular all white powder coated canopy



Optional load bars for loading pipes, ladders and other long items



Telescopic slide for access to additional storage as well as rear mounted storage boxes



Contractors roof rack and side sliding windows also available

Contact us for commercial and fleet requirements

Bed Racks

R10990 for double cabs
R11990 for super cabs

All aluminium Bed Racks featuring our unique T-Slot extrusions
350kg capacity, evenly distributed
6 x eye hooks and fitment included
Drilling required on certain vehicles
Fits Armadillo, Superior Cover and Armadillo (with accessory track)
Various accessories available
1425mm x 1512mm (Double cabs)
1425mm x 1782mm (Super cabs)



Bed Rack + Canvas Tent Combo
R26980 for double cabs
R27980 for super cabs

Bed Rack + Loadslider Combo
from R27980 for double cabs
from R29980 for super cabs



Coming Soon - Overland Bed Racks

Modular no drill design
All aluminium construction
Multiple add on accessories
Easy to fit & remove

from R15990 incl.vat



Package Specials

R35000 for double cabs
R37000 for super cabs
POA for single cabs

Weekender Camping Package

- Our most popular package we have ever offered
- Perfect for weekend trips or a great starting point for an overlanding setup
- Additional accessories can be added to this package
- Save over R2000 when ordering this package

This package includes:

- Pro Series Canopy
- Roof rails (used to mount load bars/tents/racks etc)
- Two kitchen units
- Aluminium table and slide
- 3 x LED lights wired to a cigarette socket *wiring of vehicle R890 extra
- Fitment included at our factory



Pro Series Canopy.

Smooth or tread panels
Three pop up doors
LED brake light + harness
Roof rails
Pressure vent
3 ton capacity
12 year warranty

Frame colour choices;
black, white, silver or charcoal

Roof & doors colour choices;
black, white, silver or charcoal



Two kitchen units
Easy to fit and remove
Various accessories available to kit out your kitchen units
Lightweight, all aluminium



Roof tracks/rails included



3 x white/amber LED lights



Ceiling mounted aluminium table and slide

Package Specials

R39990 for double cabs
R42990 for super cabs

Pro Series Canopy + Loadslider Package

- The most advanced and popular cargo slide on the market
- One of best combination of accessories for your bakkie for work, play or commercial
- Easily add any of our accessories to this package, over 30 accessories available

This package includes:

- Pro Series Canopy
- Loadslider
- Free perimeter rail
- Free fitment included at our factory

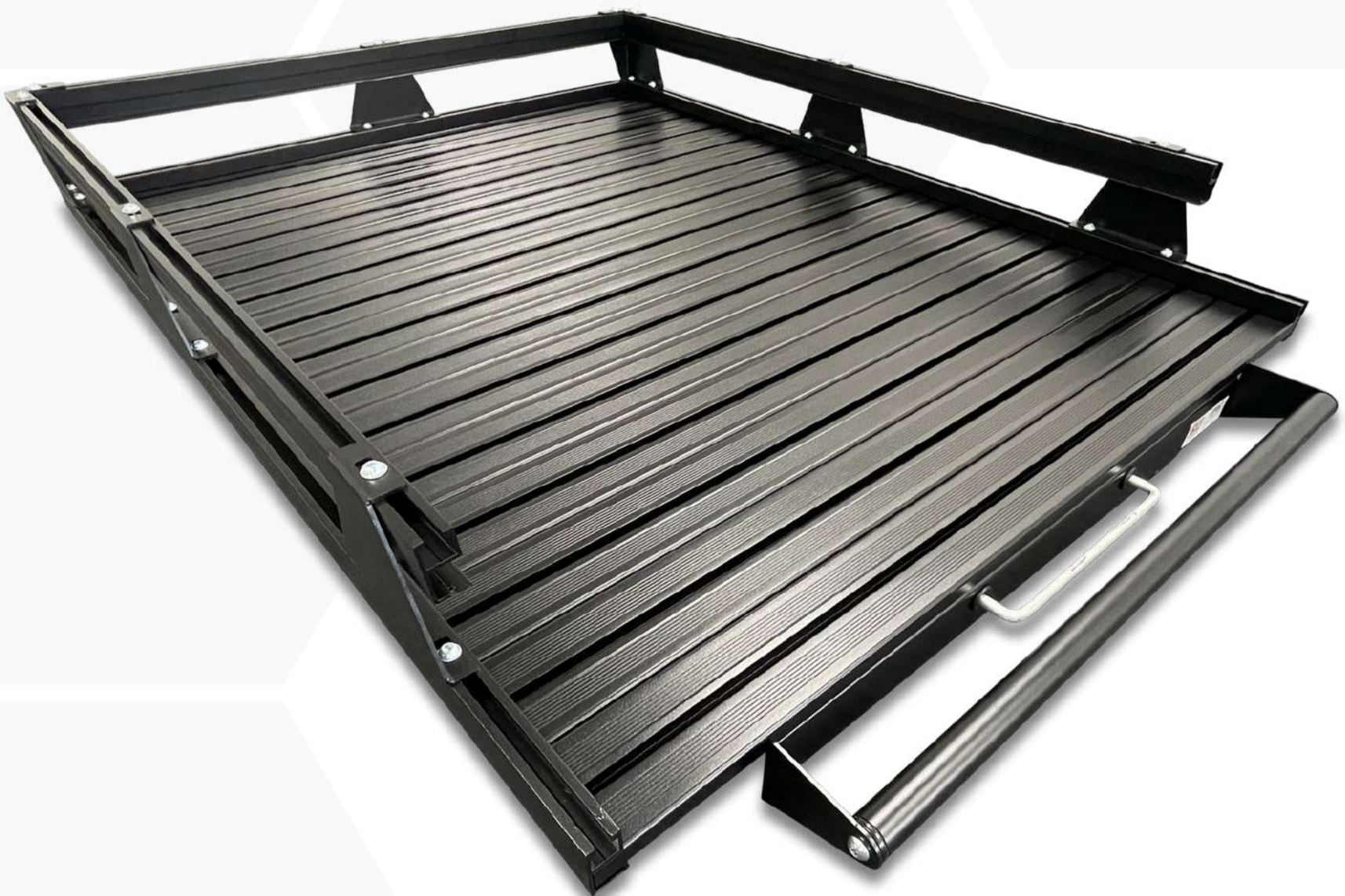

Package Specials

R155000 for double cabs

R160000 for super cabs

Overland Explorer Package

- The most fully loaded overland ready package on the market
- Fully kitted package for overlanding

This package includes:

- Pro Series Canopy
- Loadslider with perimeter rail
- Two person pop up rooftop tent
- 270 degree awning
- Dual battery wiring
- National Luna DC25 battery box
- Lithium battery
- 150W solar panel
- 90 litre National Luna fridge
- Ceiling mounted aluminium table
- Telescopic ammo box slide
- 3 x ammo boxes & stretchy straps
- 2 x kitchen units
- Drop down kitchen unit prep shelf
- Canvas cutlery bag
- Heat insulation fitted to ceiling of canopy
- 50 litre water tank and hose kit
- 3 x internal LED lights



Where to Purchase

- Direct from our factory in Wadeville, Germiston
- Buy online and we can deliver to your home or work address. All of our products are easy to fit
- From any car dealership when buying a new or used vehicle. This gives you the opportunity to add your canopy or any of our products to the finance deal
- From one of our appointed dealers listed on our website
- From your local canopy centre or 4x4 shop



Road, Sea and Air Freight Available

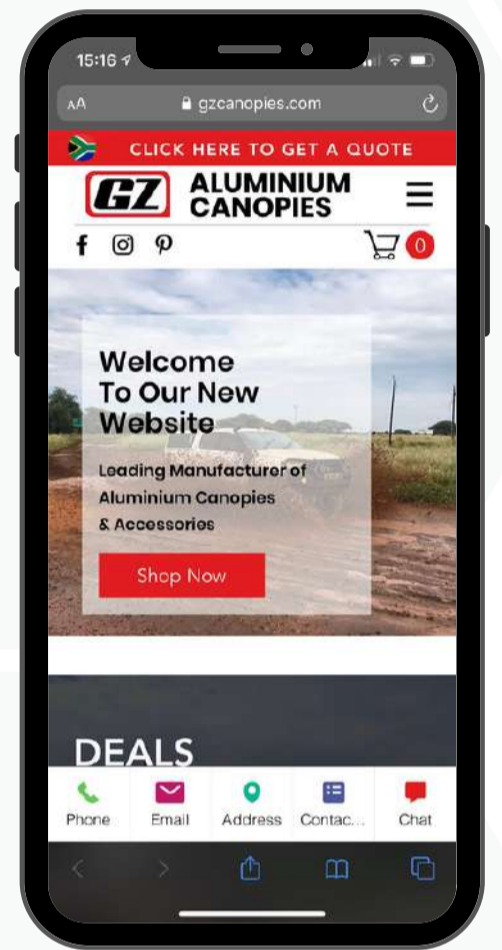

Shop Online

Dealers & Distributors

To find out more about becoming a dealer or distributor please email us at dealers@gzcanopies.co.za



Contact Us

www.gzcanopies.co.za

info@gzcanopies.co.za

011 902 0217 or 060 972 0711

Unit 7, 6 Crocker Road, Wadeville 1422

Social Media Contacts



<https://www.facebook.com/gzcanopies/>



<https://www.instagram.com/gzaluminiumcanopies/>



**ALUMINIUM
CANOPIES**